

Luminaires not suitable for covering with thermally insulating material

Gli apparecchi non sono idonei ad essere coperti con materiale termoisolante

// **Avvertenze.** La sicurezza dell'apparecchio è garantita solamente con l'uso appropriato delle presenti istruzioni che devono essere lette e conservate. • Togliere tensione di rete prima della sostituzione delle lampade e comunque prima di ogni operazione di manutenzione. • Non coprire l'apparecchio con panni o con quant'altro possa causare un eccessivo surriscaldamento. • La nostra azienda declina ogni responsabilità per danni causati da uno scorretto utilizzo o dalla manomissione dell'apparecchio stesso. • Per la sostituzione di componenti usurati rivolgersi a personale qualificato. • L'apparecchio non deve essere smaltito come rifiuto urbano. Deve essere soggetto a raccolta separata per evitare danni all'ambiente nel rispetto della direttiva 2002/96 e delle leggi nazionali per lo smaltimento del prodotto a fine vita. Il mancato rispetto di quanto sopra è sanzionato dalla Legge. • Si prega di informarsi in merito al sistema locale di raccolta differenziata per i prodotti elettrici ed elettronici. Apparecchio per uso solo in ambienti interni. Qualora il cavo flessibile fosse danneggiato, dovrà essere sostituito esclusivamente dal produttore mediante un suo incaricato oppure da un tecnico qualificato.











// **Warning.** The safety of the fixture is guaranteed only under the correct use of the present instructions, which have to be read and kept. • Turn off the net voltage before the replacement of the lamp and however before any maintenance action. • Do not cover the fixture with clothes or something else which could cause an excessive overheating. • Our company declines all responsibility for damages caused by an incorrect use or by the tampering of fixture itself. • For replacement of worn out components please address to the skilled staff. • The fixture could not be disposed as urban waste. It must be subject to separate waste collection to avoid environmental damage in compliance with directive 2002/96 and national laws for the disposal of product at the end of its working life. The non-compliance of the above mentioned directive will be sanctioned by Law. • We ask you to kindly get information about local separate waste collection system for electric and electronic products. For indoor use only. If the external flexible cable is damaged it shall be replaced exclusively by the manufacturer by his service agent or by a qualified technicians.

HALL LED PRO

// Istruzioni per il montaggio // Assembly instructions

CE

A+

-  5 years warranty
-  Direct Emission
-  UGR <19
-  IP 44
-  3000K/4000K
-  >103 lm/W
-  CRI >90
-  Eye safety: RG0/RG1
-  Mac Adams 3
-  L80/B10 >50.000h



Attenzione: prima di procedere con ciascuna delle seguenti operazioni, togliere la tensione di rete ed utilizzare i guanti in dotazione.

Attention: before proceeding with each of the following operations, switch off the power supply at the consumer unit. Use the gloves supplied.

Attention: avant de procéder aux opérations suivantes, éteignez la tension de ligne et utilisez les équipements de protection individuelle (gants, lunettes, chaussures).



Attenzione: NON ADATTO ALL'INSTALLAZIONE ALL'ESTERNO
Attention: NOT SUITABLE FOR OUTDOOR APPLICATION

esse-ci
LIVING LIGHT

Esse-Ci Srl
Viale del Lavoro 25, 35010 Vigonza (PD) Italy
Tel. +39 049 8959511
info@esse-ci.it,
www.esse-ci.it

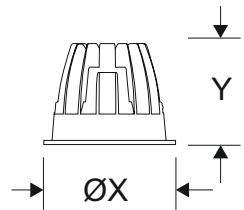
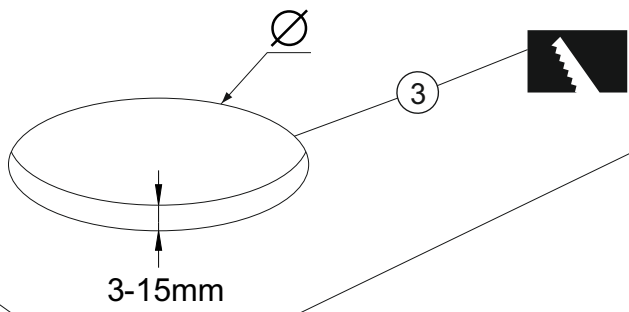
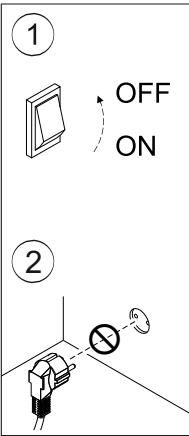

Type	ØX	Y	Ø
Mini	76	57	68
Easy Pro Small	138	105	125
Pro Medium	165	137	150
Pro Large	200	145	175

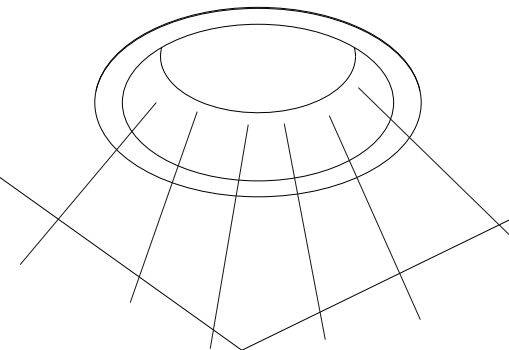
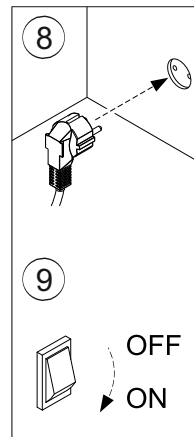
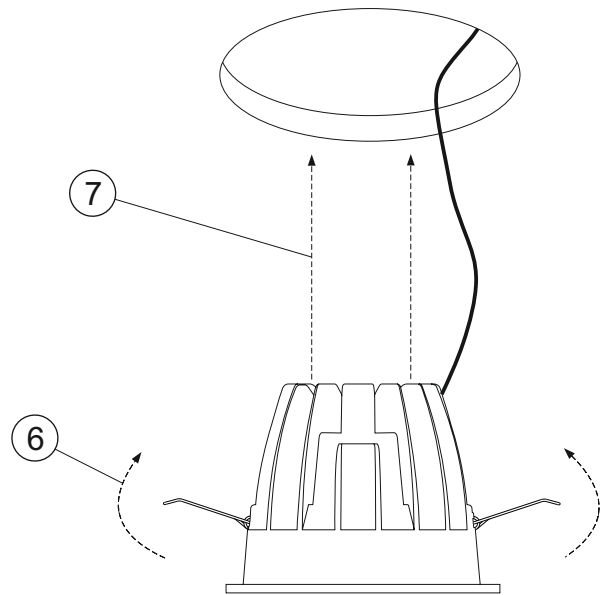
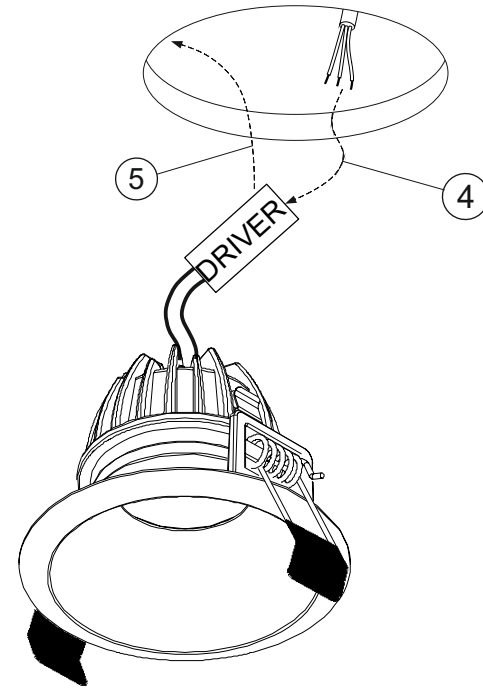

Non guardare la fonte di luce
Do not stare at the light source